



Elevating construction to new heights

We offer

- Mobile Crane Hire
- Contract Lifting
- Specialist Transport
- Machinery Removals & Installation
- Mini Crawler Cranes

Liebherr LTR 1100





Lifting Capacity



Load (mt)	No. of sheaves	No. of lines	Weight (kg)
100	7	14	1240
90.2	5	11	700
59.1	3	7	500
26.1	1	3	450
8.8	-	1	250

Working Speeds



Drive	Infinitely variable	Rope diameter / length	Max. single line pull
	0 – 110 m/min single line	21 mm / 200 m	88 kN
	0 – 110 m/min single line	21 mm / 200 m	88 kN
	0 – 1.8 min ⁻¹		
	Approx. 60 seconds to reach 82° boom angle		
	Approx. 360 seconds for boom extension from 11.5m – 52m		

Dimensions

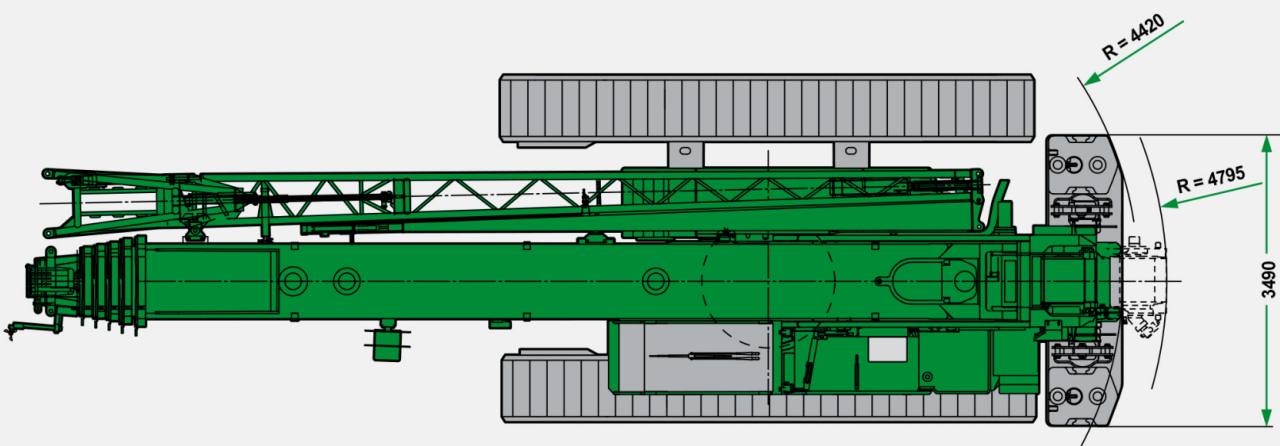
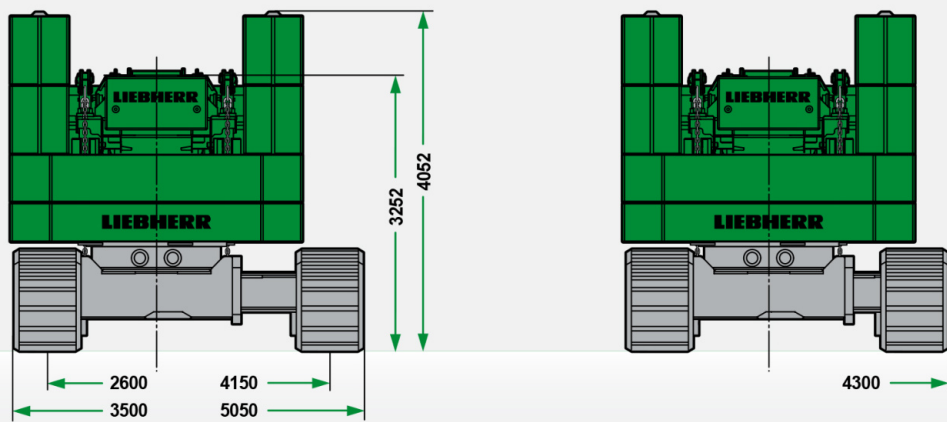
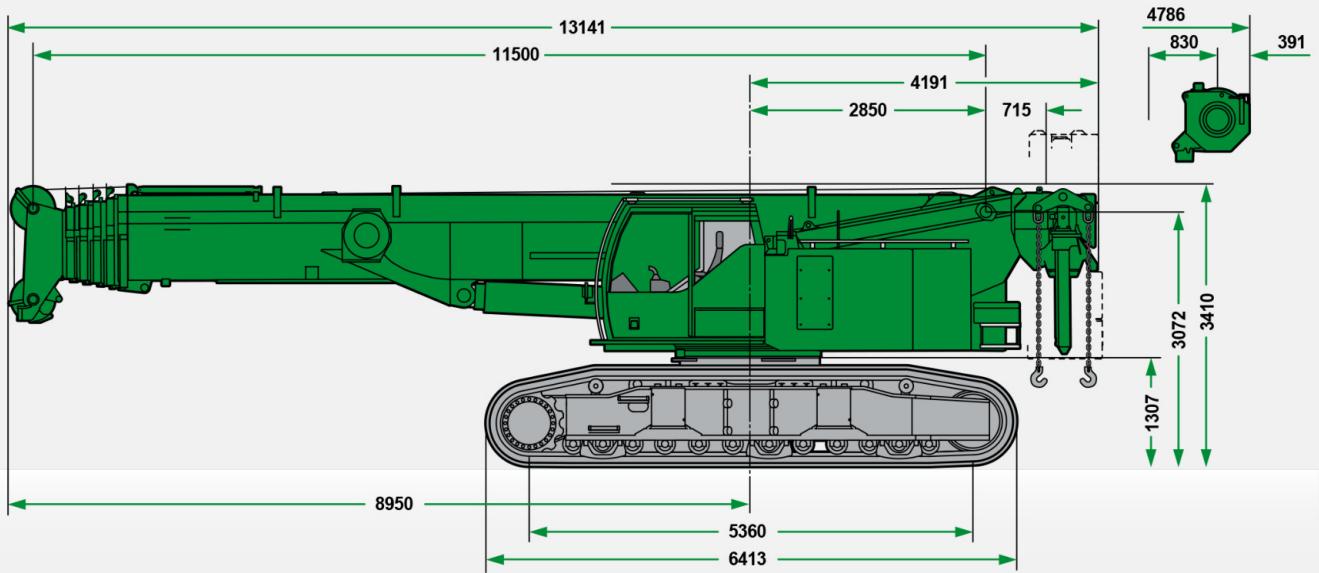

Liebherr LTR 1100

Lifting Heights

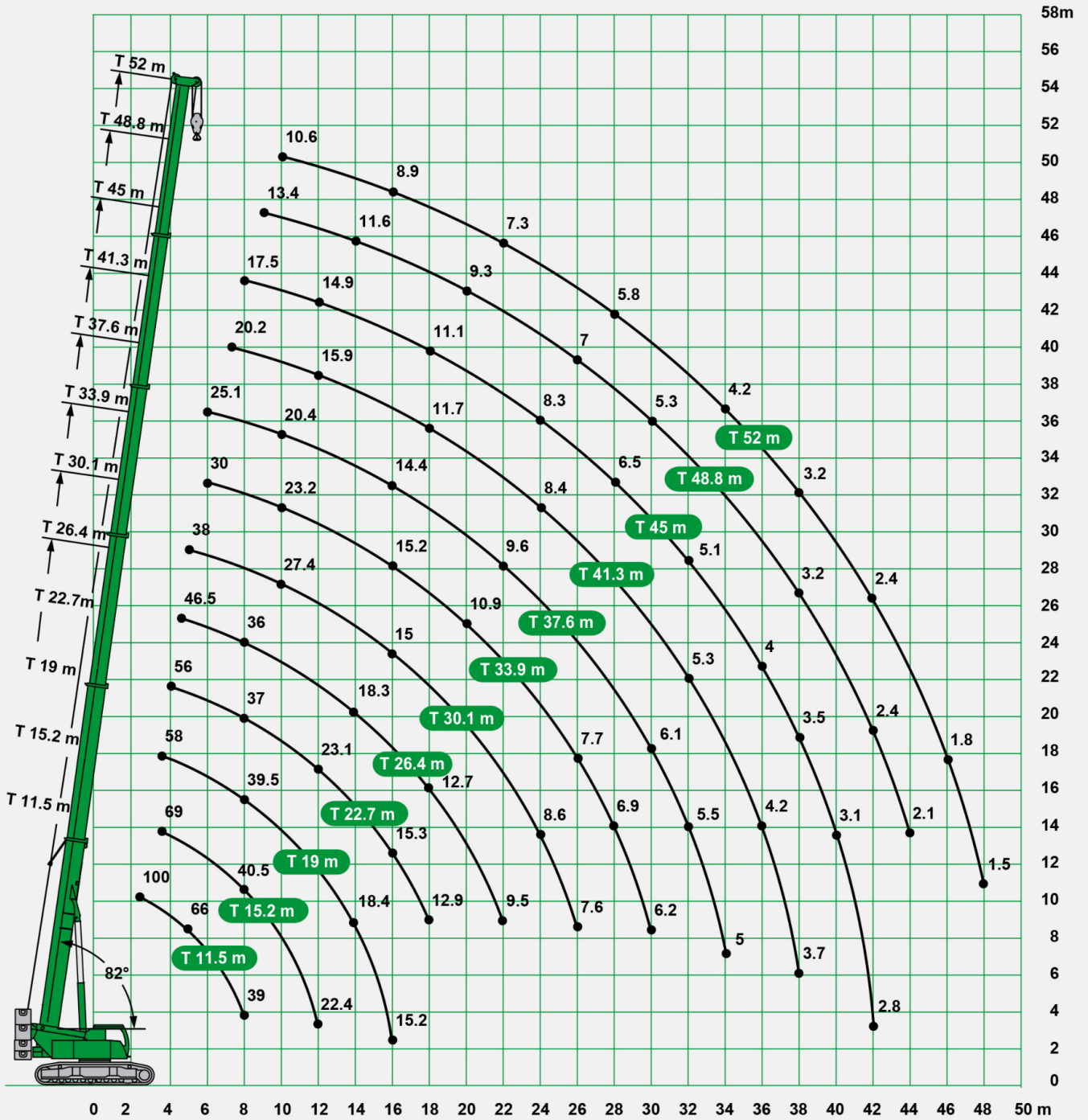

Liebherr LTR 1100

Lifting Capacities

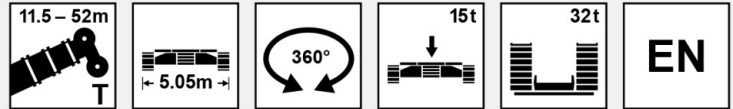



 m	11.5m	15.2m	19m	22.7m	26.4m	30.1m	33.9m	37.6m	41.3m	45m	48.8m	52m
2.5	100*											
3	85											
3.5	83	69	58									
4	77	70	59	56								
4.5	71	70	60	56	46.5							
5	66	66	60	55	46	38						
6	57	57	56	52	43.5	36.5	30	25.1				
7	48	48.5	46.5	43	41.5	34.5	28.4	24.2	20.2			
8	39	40.5	39.5	37	36	33	26.5	23.1	19.6	17.5		
9		33.5	33.5	33	31.5	31	24.8	21.7	18.8	17	13.4	
10		28.8	28.4	30	29	27.4	23.2	20.4	17.8	16.5	13	10.6
12		22.4	23	23.1	22.9	22.1	20.7	18.1	15.9	14.9	12.3	10
14			18.4	18.5	18.3	18	17.7	16.1	14.3	13.5	11.6	9.4
16			15.2	15.3	15.1	15	15.2	14.4	12.9	12.2	10.9	8.9
18				12.9	12.7	13.2	12.8	12.5	11.7	11.1	10.1	8.4
20					11	11.3	10.9	10.6	10.6	10	9.3	7.9
22					9.5	9.8	9.7	9.6	9.3	9	8.5	7.3
24						8.6	8.5	8.4	8.4	8.3	7.8	6.7
26						7.6	7.7	7.4	7.5	7.4	7	6.2
28							6.9	6.8	6.6	6.5	6	5.8
30							6.2	6.1	6	5.7	5.3	5.3
32								5.5	5.3	5.1	4.7	4.7
34								5	4.7	4.5	4.2	4.2
36									4.2	4	3.6	3.6
38									3.7	3.5	3.2	3.2
40										3.1	2.8	2.8
42										2.8	2.4	2.4
44											2.1	2.1
46												1.8
48												1.5

* 16t counterweight slabs

Liebherr LTR 1100

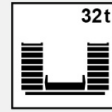
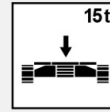
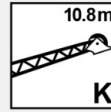
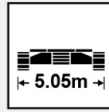
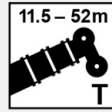
Lifting Capacities



 m	11.5m			37.6m			41.3m			45m			48.8m			52m		
	10.8m			10.8m			10.8m			10.8m			10.8m			10.8m		
	0°	20°	40°	0°	20°	40°	0°	20°	40°	0°	20°	40°	0°	20°	40°	0°	20°	40°
4	12																	
4.5	11.6																	
5	11.2																	
6	10.4																	
7	9.5	9.5		13.5														
8	8.6	8.9		13.1			11.9											
9	7.9	8.3		12.8			11.7			9.5			7.6					
10	7.2	7.8	7.5	12.5			11.5			9.2			7.4			6.1		
12	6.2	6.8	6.8	11.9	10.4		11.1	10		8.8			7			5.7		
14	5.3	5.8	6.2	11.2	9.8	8.5	10.5	9.5		8.4	7.9		6.7	6.5		5.4	5.2	
16	4.6	5	5.3	10.5	9.2	8.1	9.9	9.1	8	8	7.5	7.2	6.4	6.1		5.2	4.9	
18	4.2	4.4	4.9	9.6	8.6	7.7	9.1	8.6	7.6	7.5	7.1	6.8	6.1	5.8	5.6	4.9	4.7	4.6
20				8.8	8.1	7.3	8.3	8.1	7.3	7.2	6.7	6.5	5.8	5.5	5.4	4.6	4.5	4.4
22				8.1	7.7	7	7.6	7.7	7	6.8	6.4	6.2	5.5	5.3	5.2	4.4	4.2	4.2
24				7.5	7.3	6.7	7	7.1	6.8	6.3	6.1	5.9	5.2	5	5	4.2	4	4
26				6.9	6.9	6.5	6.4	6.5	6.5	5.8	5.8	5.7	5	4.8	4.8	4	3.8	3.8
28				6.2	6.4	6.3	5.7	6	6.1	5.4	5.5	5.5	4.8	4.6	4.6	3.8	3.7	3.6
30				5.4	5.7	6	5.4	5.4	5.7	5	5.1	5.3	4.6	4.4	4.4	3.6	3.5	3.5
32				4.7	5	5.2	4.8	5	5	4.4	4.8	4.9	4.4	4.3	4.3	3.5	3.4	3.4
34				4.1	4.4	4.6	4.2	4.5	4.7	4.3	4.1	4.4	4	4.1	4.2	3.3	3.3	3.2
36				3.7	3.8	4	3.9	3.9	4.1	3.8	4	4	3.5	3.8	4	3.2	3.1	3.1
38				3.5	3.6	3.6	3.6	3.7	3.8	3.4	3.6	3.7	3	3.3	3.4	2.9	3	3
40				3.4	3.4	3.5	3.2	3.4	3.5	2.9	3.1	3.3	2.6	2.8	3	2.5	2.8	3
42				3.1	3.2	3.2	2.8	3	3	2.6	2.8	2.9	2.2	2.4	2.6	2.2	2.4	2.6
44				2.8	2.9		2.5	2.6	2.7	2.2	2.4	2.5	1.9	2.1	2.2	1.8	2	2.2
46							2.2	2.3		2	2.1	2.1	1.6	1.8	1.8	1.5	1.7	1.8
48							2	2		1.7	1.8	1.8	1.3	1.5	1.5	1.3	1.4	1.5
50										1.5	1.5		1.1	1.2	1.2	1	1.2	1.2
52										1.2			0.9	1	1	0.8	0.9	1

Liebherr LTR 1100

Lifting Capacities

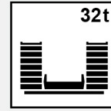
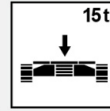
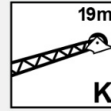
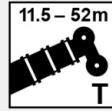

 m	11.5m			37.6m			41.3m			45m			48.8m			52m		
	19m			19m			19m			19m			19m			19m		
	0°	20°	40°	0°	20°	40°	0°	20°	40°	0°	20°	40°	0°	20°	40°	0°	20°	40°
6	4.5																	
7	4.3																	
8	4.1			5.1														
9	3.9			5			4.8											
10	3.7			4.9			4.7			4.4								
12	3.4	3		4.7			4.6			4.3			3.9			3.5		
14	3.1	2.8		4.5			4.4			4.2			3.9			3.4		
16	3	2.7	2.5	4.2	3.3		4.2	3.2		4			3.7			3.3		
18	2.8	2.5	2.4	4	3.1		4	3.1		3.9	3.1		3.6	3		3.2		
20	2.7	2.5	2.3	3.8	3	2.5	3.8	3		3.7	3		3.5	2.9		3.1	2.8	
22	2.6	2.4	2.3	3.6	2.9	2.5	3.6	2.9	2.5	3.5	2.9	2.5	3.4	2.8		3.1	2.7	
24	2.5	2.4	2.3	3.5	2.8	2.4	3.5	2.8	2.4	3.4	2.8	2.4	3.2	2.7	2.4	3	2.7	2.3
26	2.5	2.4	2.3	3.3	2.7	2.4	3.3	2.7	2.4	3.3	2.7	2.4	3.1	2.6	2.3	2.9	2.6	2.3
28				3.2	2.7	2.4	3.2	2.7	2.4	3.2	2.6	2.3	3	2.6	2.3	2.7	2.5	2.3
30				3.1	2.6	2.3	3.1	2.6	2.3	3.1	2.6	2.3	3	2.5	2.3	2.6	2.5	2.3
32				3	2.5	2.3	3	2.6	2.3	3	2.5	2.3	2.9	2.5	2.3	2.5	2.4	2.3
34				2.9	2.5	2.3	2.9	2.5	2.3	2.9	2.5	2.3	2.8	2.5	2.3	2.5	2.4	2.2
36				2.8	2.5	2.3	2.8	2.5	2.3	2.8	2.5	2.3	2.7	2.4	2.3	2.4	2.3	2.2
38				2.7	2.5	2.3	2.8	2.5	2.3	2.8	2.4	2.3	2.7	2.4	2.3	2.3	2.2	2.2
40				2.6	2.4	2.3	2.7	2.4	2.3	2.7	2.4	2.3	2.6	2.4	2.3	2.2	2.2	2.2
42				2.6	2.4	2.3	2.6	2.4	2.3	2.6	2.4	2.3	2.6	2.3	2.3	2.1	2.1	2.1
44				2.5	2.4	2.3	2.5	2.4	2.3	2.6	2.4	2.3	2.2	2.3	2.3	2.1	2	2.1
46				2.4	2.4	2.3	2.5	2.4	2.3	2.3	2.4	2.3	1.9	2.3	2.3	1.9	2	2
48				2.4	2.4	2.3	2.2	2.4	2.3	2	2.3	2.3	1.7	2	2.2	1.6	1.9	2
50				2.3	2.4	2.3	2	2.2	2.3	1.7	2	2.1	1.4	1.7	1.9	1.3	1.7	1.9
52				2.1	2.1		1.8	1.9	2	1.5	1.7	1.8	1.2	1.4	1.6	1.1	1.4	1.6
54							1.6	1.7		1.3	1.5	1.5	1	1.2	1.3	0.9	1.2	1.3
56							1.4	1.4		1.1	1.2	1.3	0.8	1	1		0.9	1
58										0.9	1				0.8			0.8

Liebherr LTR 1100

Lifting Heights

